



MEMBER OF:

LOCATION

12" WIDE 9960 ZIP TRENCH™

FUNCTION: Used in all surface drainage applications. May be assembled in any length utilizing self aligning channel ends. This reduces installation times and cost, providing an engineered, sloped solution for drainage requirements.

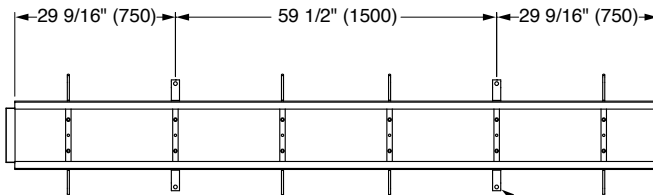
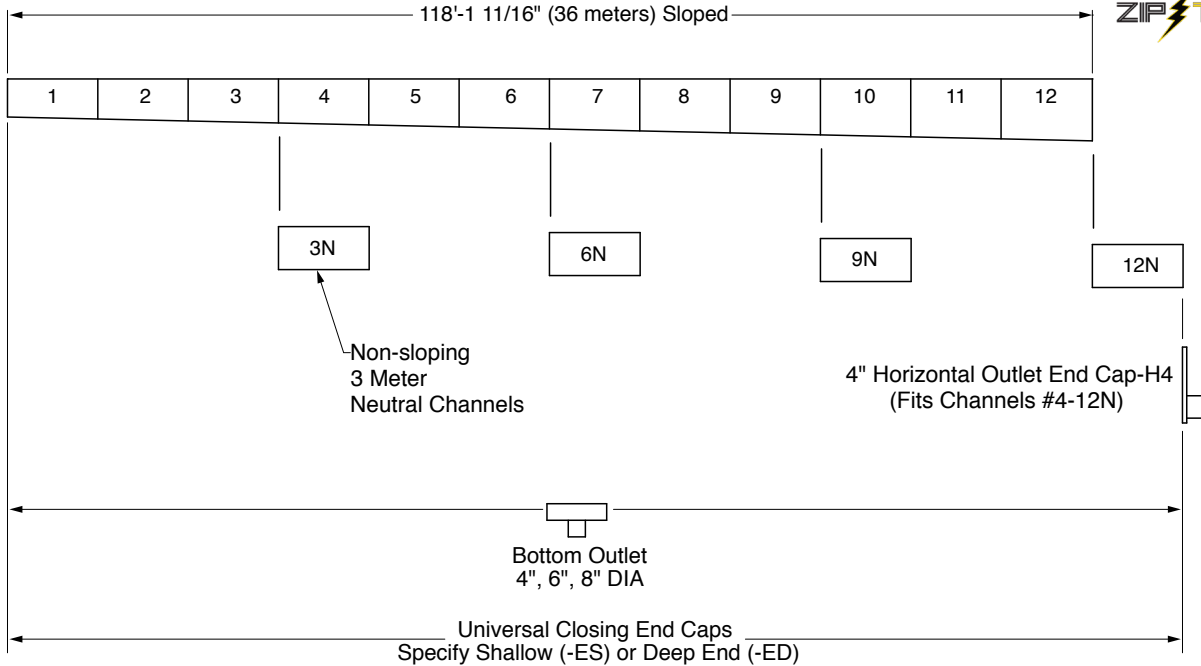

TOP VIEW

Welded Installation Device For Rebar Support (4 Per Frame) (Rebar Posts By Others)

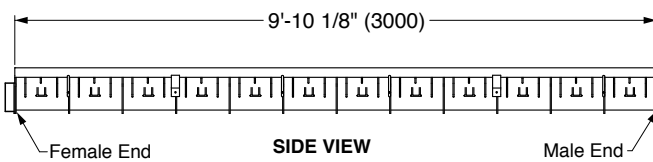

SIDE VIEW

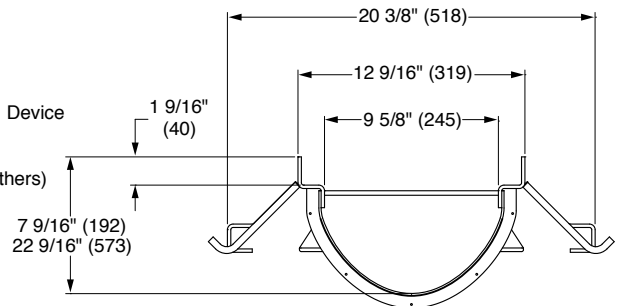

ENLARGED END VIEW

REGULARLY FURNISHED:
 12 9/16" (319) wide, 3 meters (9.84') long, 100% Polypropylene Channel with UV Inhibitors and Coated Steel Frame. Channels connect with 2" Overlap Joint. Design has a Built In Slope of 1.07% with Radiused Bottom. Supplied with Secured Grate per Specification.

VARIATIONS:

- Grate Specifications (See Back)
- Closing End Cap Shallow -ES
- Closing End Cap Deep -ED
- Horizontal Outlet 4", 6", 8" -H468
- 4"/6"/8" NO-HUB Bottom Outlet -V468

OPTIONAL RAIL MATERIAL:

- Galvanized Steel
- Type 304 Stainless Steel

Note: Dimensions in parentheses are in mm.
Note: This Trench Drain System is Designed for "On Grade Applications Only" as There are No Provisions for a Flashing Flange or Flashing Clamp.

DRAWING NUMBER: S9960
 SIZE: A
 SCALE: NONE
 DATE: 3-8-16
 APPROVED BY: PJ
 CHECKED BY: PJ
 DRAWN BY: TBW
 DIMENSIONS ARE SUBJECT TO MANUFACTURERS TOLERANCE AND CHANGE WITHOUT NOTICE
 WE CAN ASSUME NO RESPONSIBILITY FOR USE OF SUPERSEDED OR VOID DATA

9960

FIGURE NUMBER	A	4-5-16	Revised Title	TBW	PJ
REV.	DATE	DESCRIPTION		BY	CKD. BY

WEIGHT POUNDS	VOLUME CUBIC FEET

FIGURE NUMBER
9960

9960 ZIP TRENCH™

DRAWING NUMBER: **S9960-BS**

SIZE: **A**

SCALE: **NONE**

DATE: **3-8-16**

APPROVED BY: **PJ**

CHECKED BY: **PJ**





DRAWN BY: **TBW**

9960-BS

DIMENSIONS ARE SUBJECT TO MANUFACTURERS TOLERANCE AND CHANGE WITHOUT NOTICE

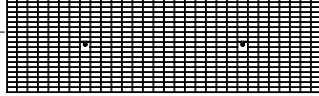
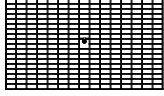
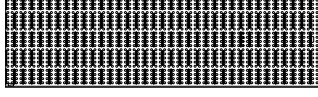
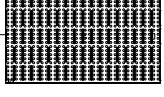
WE CAN ASSUME NO RESPONSIBILITY FOR USE OF SUPERSEDED OR VOID DATA

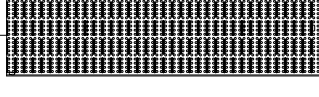
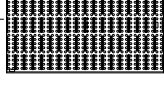
**Heavy Duty DIN 19580 Load Class C:
 56,000 lbs - 1,162 psi. For commercial
 pneumatic tire traffic patterns, forklifts (pneumatic tire)
 and tractor trailers (pneumatic tire).**

- 9960-GM1**- Galv. steel mesh grate (309.56 sq. in.) 1 meter 
- 9960-GM5**-Galv. steel mesh grate (157.62 sq. in.) 1/2 meter 
- 9960-GP1**-Perforated galv. steel grate (78.00 sq. in.) 1 meter 
- 9960-GP5**-Perforated galv. steel grate (39.00 sq. in.) 1/2 meter 
- 9960-SSM1**-Stainless steel mesh grate (309.56 sq. in.) 1 meter 
- 9960-SSM5**-Stainless steel mesh grate (157.62 sq. in.) 1/2 meter 
- 9960-SSP1**-Perforated stainless steel grate (78.00 sq. in.) 1 meter 
- 9960-SSP5**-Perforated stainless steel grate (39.00 sq. in.) 1/2 meter 
- 9960-MC**-Ductile iron slotted grate (87.87 sq. in.) 1/2 meter 
- 9960-MADAC**-Ductile iron ADA slotted grate (58.00 sq. in.) 1/2 meter 

**Extra Heavy Duty, DIN 19580 Class E:
 135,000 lbs - 2,788 psi. For commercial solid
 tire traffic patterns, forklifts and impacts from
 steel struts or metal wheels.**

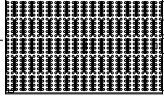
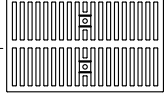
- 9960-M**-Ductile iron slotted grate (87.87 sq. in.) 1/2 meter 
- 9960-MADA**-Ductile iron ADA slotted grate (58.00 sq. in.) 1/2 meter 

HYDRAULIC CAPACITY AND DEEP END DEPTHS 9960 SYSTEM

Channel Number	Shallow End Invert Inch	End Invert mm	Slope	Deep End Invert mm	Invert Inch	Slope	Single Channel Est. CFS	Est. GPM	Weight Lbs.
9960-1	7.56	192	1.07%	8.81	224	1.07%	1.85	830	76.00
9960-2	8.81	224	1.07%	10.06	256	1.07%	2.68	1205	79.00
9960-3	10.06	256	1.07%	11.31	287	1.07%	3.13	1407	81.00
9960-3N	11.31	287	0.0%	11.31	287	0.0%	3.13	1407	81.00
9960-4	11.31	287	1.07%	12.56	319	1.07%	3.92	1760	83.00
9960-5	12.56	319	1.07%	13.81	351	1.07%	4.43	1990	86.00
9960-6	13.81	351	1.07%	15.06	383	1.07%	4.94	2220	89.00
9960-6N	15.06	383	0.0%	15.06	383	0.0%	4.94	2220	89.00
9960-7	15.06	383	1.07%	16.31	414	1.07%	5.46	2450	92.00
9960-8	16.31	414	1.07%	17.56	446	1.07%	5.97	2680	94.00
9960-9	17.56	446	1.07%	18.81	478	1.07%	6.48	2910	97.00
9960-9N	18.81	478	0.0%	18.81	478	0.0%	6.48	2910	97.00
9960-10	18.81	478	1.07%	20.06	510	1.07%	7.00	3140	99.00
9960-11	20.06	510	1.07%	21.31	541	1.07%	7.51	3370	103.00
9960-12	21.31	541	1.07%	22.56	573	1.07%	8.00	3600	106.00
9960-12N	22.56	573	0.0%	22.56	573	0.0%	8.00	3600	106.00

Note: Channel flow rates based on channels less grates and open ended.



F E D C	3-20-19 6-12-18 4-20-17 1-4-16	Revised Load Class C Added Grates Revised Table Revised Table	MW TBW TBW TBW	PJ PJ PJ PJ	WEIGHT POUNDS	VOLUME CUBIC FEET	FIGURE NUMBER 9960-BS
REV.	DATE	DESCRIPTION	BY	CKD. BY			