

D  
DRAWING NUMBER  
S0230Y-M54-XX  
SIZE  
A  
SCALE:  
NONE  
DATE:  
10/08/07  
APPROVED BY:  
CL  
CHECKED BY:  
CL  
DRAWN BY:  
JJ

**SMITH® JAY R. SMITH MFG. CO.®**  
MEMBER OF MORRIS GROUP INTERNATIONAL  
POST OFFICE BOX 3237  
MONTGOMERY, ALABAMA 36109-0237 (USA)  
TEL: 334-277-8520 FAX: 888-377-7818 www.jrsmith.com

**ASPE**  
MEMBER OF:  
**ASPE**

LOCATION

# ADJUSTABLE FIXTURE SUPPORTS FOR SIPHON JET WATER CLOSETS

## NO-HUB VERTICAL FITTINGS EXTRA HEAVY DUTY - 750 LBS.

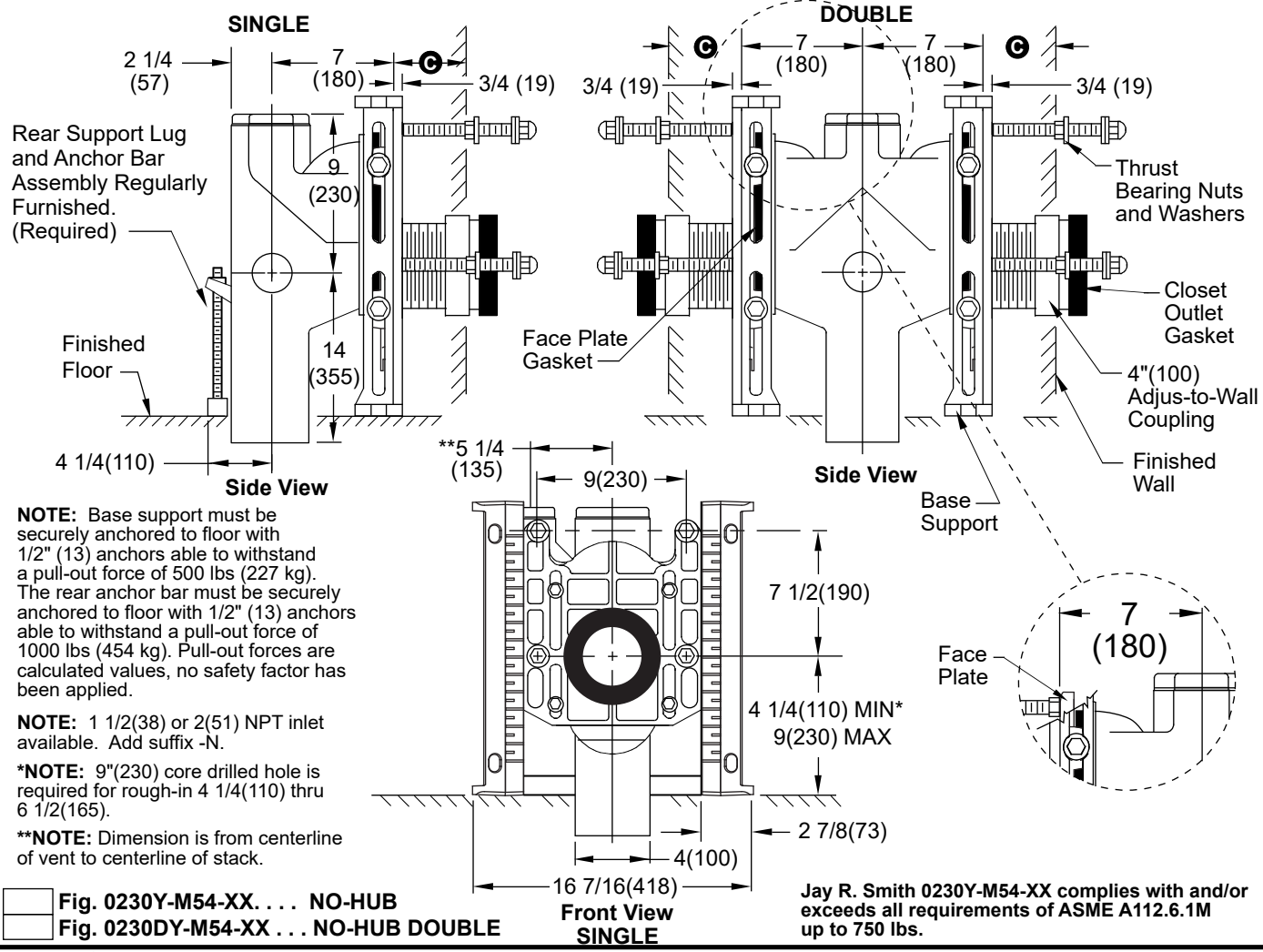

**Ⓞ DIMENSION - ADJUS-TO-WALL TYPE OUTLET CONNECTION**  
The Smith Adjus-to-Wall outlet connection provides adjustment at the face of the wall at the time the fixture is set; thus, compensating for wall construction variations. The Ⓞ dimension is measured from the front of the face plate to the finished wall. To properly determine the length of nipple required, deduct 1"(25) from the Ⓞ dimension. When the Ⓞ dimension exceeds 7" (180), the -M40 Wide Pipe Chase Support is recommended. The Adjus-to-Wall coupling will provide 1/2"(13) horizontal adjustment in either direction with the coupling extended 5/16"(8) past face of the finished wall.  
Ⓞ dimension = 4"(100) (regularly furnished) consisting of nipple and Adjus-to-Wall coupling permitting adjustment from 3"(76) min. to 4"(100) max.  
**NOTE:** When nipple lengths between 3 1/4"(83) and 8 1/4"(210) are specified, the 8 1/4"(210) nipple will be supplied.  
**NOTE:** Dimensions shown in parentheses are in millimeters. Nipple must be cut to specified length by others.

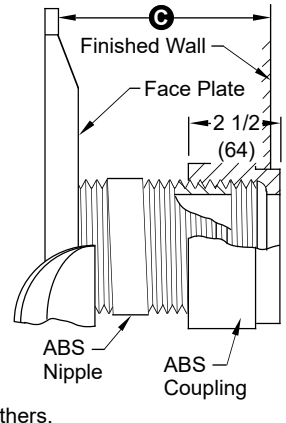

NIPPLE LENGTHS AVAILABLE

LENGTH	MIN.	Ⓞ	MAX.
2 1/2(64)	2 1/4(57)	3 1/4(83)	
*3 1/4(83)	3(76)	4(100)	
*8 1/4(210)	8(205)	9(230)	
10(255)	9 3/4(250)	10 3/4(275)	
12(305)	11 3/4(300)	12 3/4(325)	
15(380)	14 3/4(375)	15 3/4(400)	
18(455)	17 3/4(450)	18 3/4(475)	

\*ABS (Regularly Furnished) other lengths PVC.

REV.	DATE	DESCRIPTION	BY	CKD. BY	WEIGHT POUNDS	VOLUME CUBIC FEET	FIGURE NUMBER
D	2-1-24	Revised Adjus-to-Wall	HS	CL			<b>0230Y-M54-XX</b>
C	11/20/09	3/4 (19) was 1/2 (13)	JJ	CL			
B	5-13-08	Revised Note	TBW	CL			
A	11/20/07	Moved Dimensions	JJ	CL			

# MODIFICATIONS & VARIATIONS

## Ⓢ DIMENSION - ADJUS-TO-WALL TYPE OUTLET CONNECTION

The Smith Adjus-to-Wall outlet connection provides adjustment at the face of the wall at the time the fixture is set; thus, compensating for wall construction variations. The Ⓢ dimension is measured from the front of the face plate to the finished wall. To properly determine the length of nipple required, deduct 1" (25) from the Ⓢ dimension. When the Ⓢ dimension exceeds 7" (180), the -M40 Wide Pipe Chase Support is recommended. The Adjus-to-Wall coupling will provide 1/2" (13) horizontal adjustment in either direction with the coupling extended 5/16" (8) past face of the finished wall.

Ⓢ dimension = 4" (100) (regularly furnished) consisting of nipple and adjus-to-wall coupling permitting adjustment from 3" (76) min. to 4" (100) max.

\*ABS (Regularly Furnished) other length PVC.

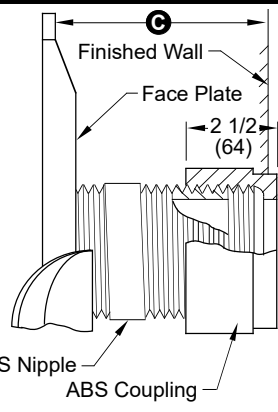

### NIPPLE LENGTHS AVAILABLE

LENGTH	MIN	Ⓢ MAX
2 1/2 (64)	2 1/4 (57)	3 1/4 (83)
*3 1/4 (83)	3 (76)	4 (100)
*8 1/4 (210)	8 (205)	9 (230)
10 (255)	9 3/4 (250)	10 3/4 (275)
12 (305)	11 3/4 (300)	12 3/4 (325)
15 (380)	14 3/4 (376)	15 3/4 (400)
18 (455)	17 3/4 (450)	18 3/4 (475)

NOTE: When nipple lengths between 3 1/4" (83) and 8 1/4" (210) are specified, the 8 1/4" (210) nipple will be supplied. Nipple must be cut to specified length by others.

## RECOMMENDED SETTING OF CLOSET OUTLET CONNECTION AND FIXTURE STUDS

Manufacturers have slight differences in the depth of the closet horn and flange thickness of their closets. Usually the fixture support closet connection should extend 5/16" (8) beyond face of finished wall (Dimension "R") and the fixture studs 2 1/4" (57) (Dimension "X"). For exact dimensions please use the formulas below.

**DETAIL A** Formula for "R" is:  $S + 1/16" (2) - D = R$   
 S = Depth of closet horn  
 1/16" (2) = Distance closet is to set away from finished wall.  
 D = 1/2" (13) for felt gasket and 3/8" (10) for neoprene gasket.  
 R = Distance coupling should extend beyond finished wall.  
 NOTE: When the fixture is installed, closet gasket must be compressed sufficiently to assure a gas and water-tight seal.

**DETAIL B** Formula for "X" is:  $Y + 1/16" (2) + 9/16" (14) = X$   
 Y = Thickness of closet wall flange.  
 1/16" (2) = Distance closet is to set away from finished wall.  
 X = Distance supporting stud should extend beyond finished wall.  
 NOTE: Bearing nuts and washers must be set to take full loading from the fixture allowing 1/16" (2) clearance between fixture and wall.

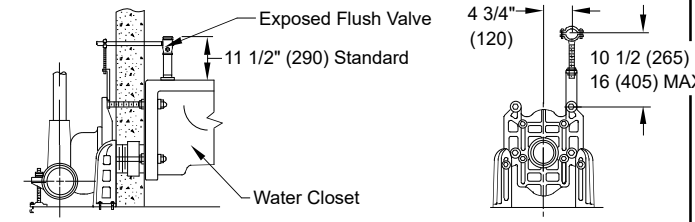
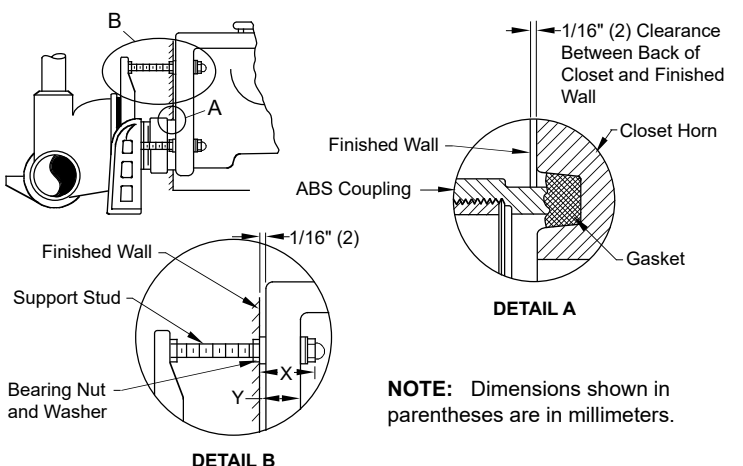

Provides support and alignment for the supply pipe to an exposed flush valve; must be specified for either 1" (25) copper tube or 1" (25) iron pipe.

**SUFFIX -M12 EXPOSED FLUSH VALVE SUPPLY SUPPORT**

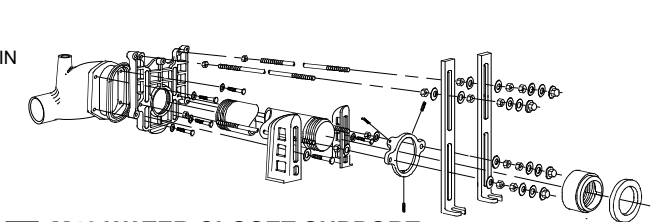

**-M40 WATER CLOSET SUPPORT FOR WIDE PIPE CHASE (USE WHEN Ⓢ DIMENSION EXCEEDS 7" (180))**

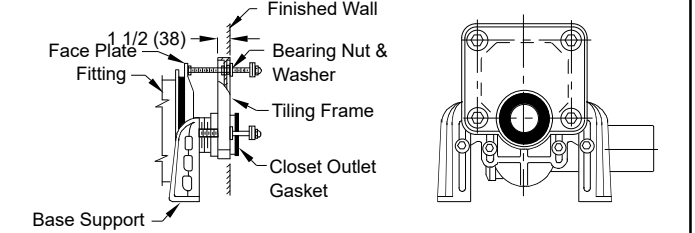

**SUFFIX -M13 TILING FRAME - POLYSTYRENE**

## CONCEALED FLUSH VALVES

A concealed flush valve when used with a blowout water closet support will not clear the face plate. Therefore 4 1/2" (115) to 6 1/2" (165) is required from back of wall to face plate to permit the installation of the concealed flush valve piping.

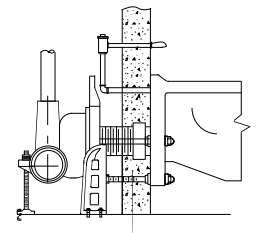

DRAWING NUMBER: S0200BS  
 SIZE: A  
 SCALE: NONE  
 DATE: 2-28-86  
 APPROVED BY: JD  
 CHECKED BY: CR  
 DRAWN BY: VGD  
 0200/0300 Series Back Sheet

WE CAN ASSUME NO RESPONSIBILITY FOR USE OF SUPERSEDED OR VOID DATA  
 DIMENSIONS ARE SUBJECT TO MANUFACTURERS TOLERANCE AND CHANGE WITHOUT NOTICE

REV.	DATE	DESCRIPTION	BY	CKD. BY
C	12-10-03	Revised Notes	RN	CL
B	6-1-95	Added Millimeters	EMB	BS
A	7-1-93	Submittal Update	EMB	BS

WEIGHT POUNDS	VOLUME CUBIC FEET
---------------	-------------------

**FIGURE NUMBER**  
**0200/0300 Series**  
**Back Sheet**