

FLOOR OR SHOWER DRAINS WITH ADJUSTABLE STRAINER HEADS

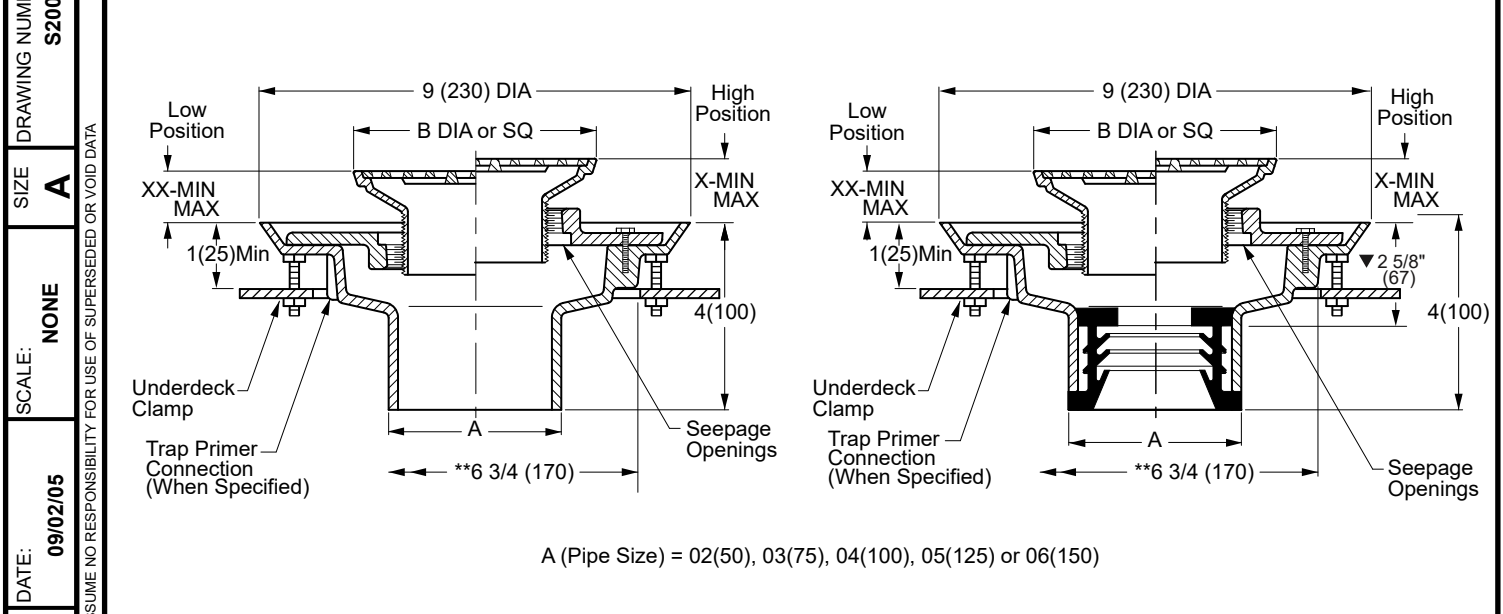

A (Pipe Size) = 02(50), 03(75), 04(100), 05(125) or 06(150)

NO-HUB OUTLET

- Fig. 2005Y(-UDC).....(A) ROUND TOP
- Fig. 2005Y(-UDC).....(B) SQUARE TOP

SPEEDI-SET® OUTLET

- Fig. 2005L(-UDC).....(A) ROUND TOP
- Fig. 2005L(-UDC).....(B) SQUARE TOP

Outlet Size	Nickel Bronze Strainer Head
▲ 02(50)	05(125) DIA or SQ
▲ 03(75)	06(150) DIA or SQ
▲ 04(100)	08(205) DIA or SQ

Strainer Size B	*Collar In High Position X		*Collar In Low Position XX		Free Area SQ IN (SQ CM)	
	MIN	MAX	MIN	MAX	ROUND	SQUARE
05 (125)	1 1/4(32)	2 1/4(57)	3/4(19)	1 5/8(41)	7(45)	6.5(42)
06 (150)	1 1/4(32)	2 1/4(57)	3/4(19)	1 5/8(41)	9(58)	12.5(81)
07 (180)	1 1/4(32)	2 1/4(57)	7/8(22)	1 7/8(48)	14(90)	11(71)
08 (205)	1 1/2(38)	2 1/2(64)	1(25)	1 7/8(48)	17(110)	14(90)
*09 (230)	1 1/2(38)	2 3/8(60)	1(25)	1 7/8(48)	18(116)	16(103)
*10 (255)	1 1/2(38)	2 3/8(60)	1(25)	1 7/8(48)	23(48)	16(103)

- ▼ This dimension to internal stop of speedi-set® gasket.
- Add 3/8"(10) to all min/max dimensions for round strainers.
- * Collar is reversible to obtain extreme high and low strainer positions.
- ** Not available for 5"(125) size strainer.
- ** MIN 6 3/4"(170) hole required for core drilled application.

REGULARLY FURNISHED:

Duco Cast Iron Body with Flashing Collar, Underdeck Clamp and Adjustable Strainer Head as Indicated by Suffix Letter Selected.

NOTE: Dimensions shown in parentheses are in millimeters.

▲ Meets ASME Standard A112.6.3-2001 02(50), 03(75) or 04"(100) sizes only.

VARIATIONS:

- Flapper Type Backwater Valve -V
- Hinged Grate -H
- L Speedi-Set® Service Weight 2(50), 3(75) & 4"(100) only
- LXH Speedi-Set® Extra Heavy 2(50), 3(75) & 4"(100) only
- Sediment Bucket -B
- Trap Primer Connection -P050 1/2" (13) & -P075 3/4" (19)
- Vandal Proof Screws -U
- Wide Flanged Strainer (Specify Fig. DX2005)
- Underdeck Clamp -UDC
- Quad Close Trap Seal (Specify Fig. 2692)

OPTIONAL MATERIALS:

- Bronze Body -BB
- Chrome Plated Strainer -CP
- Galvanized Cast Iron Body -G
- Nickel Bronze Strainer -NB
- Polished Bronze Strainer -PB
- All Stainless Steel (Specify Fig. 9700)
- Stainless Steel Strainers -SS [Available in 05(125) & 06(150) sizes only]

SEE PM 0457 FOR OPTIONAL STRAINER HEADS.

2005(-UDC)

FIGURE NUMBER	F D C	2-8-24 3-10-23 6-14-19 11-3-16	Chg'd NO-HUB to SPEEDI-SET Added @ to "Speedi-Set" Removed Function Revised Optional Materials	HS KK MW TBW	CL CL JM CL	WEIGHT POUNDS	VOLUME CUBIC FEET	FIGURE NUMBER
REV.	DATE	DESCRIPTION	BY	CKD. BY				2005(-UDC)

OPTIONAL STRAINER HEADS

DRAWING NUMBER: PM0457 SH 1 of 2
 SIZE: A
 SCALE: NONE
 DATE: 5-17-85
 APPROVED BY: TD
 CHECKED BY: TD
 DRAWN BY: PJ
 2010 SERIES OPTIONAL STRAINER HEADS

ASSUME NO RESPONSIBILITY OR USE OF SUPERSEDED OR VOID DATA
 DIMENSIONS ARE SUBJECT TO MANUFACTURERS TOLERANCE AND CHANGE WITHOUT NOTICE

ROUND STRAINER

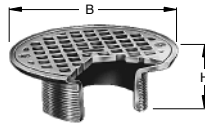

MATERIALS:
 Chrome Plated -CP
 Polished Bronze -PB
 Nickel Bronze -NB
 Stainless Steel
 Strainers -SS [Available in 05(125) & 06(150) sizes only]

VARIATIONS:
 •Hinged Grate (Specify Suffix -AH)
 Sediment Bucket -B
 Vandal Proof Screws -U

B DIA	05 (125)	06 (150)	07 (180)	08 (205)	09 (230)	10 (255)
H	2 (51)	2 (51)	2 1/4 (57)	2 1/2 (64)	2 1/2 (64)	2 3/4 (70)
X MIN	1 1/4 (32)	1 1/4 (32)	1 1/4 (32)	1 1/2 (38)	1 1/2 (38)	1 1/2 (38)
X MAX	2 1/4 (57)	2 1/4 (57)	2 1/4 (57)	2 1/2 (64)	2 1/2 (64)	2 3/4 (70)

LIGHT DUTY

SUFFIX -A

Specify Type, Size & Finish eg: A05NB
 *Not available for 05" (125) size

SQUARE STRAINER

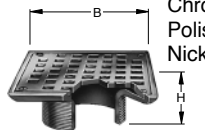

MATERIALS:
 Chrome Plated -CP
 Polished Bronze -PB
 Nickel Bronze -NB

VARIATIONS:
 Flapper Type Backwater Valve (Specify Suffix -BV) 05 (125), 06 (150), 07 (180) or 08" (205) sizes only
 *Hinged Grate (Specify Suffix -BH)
 Sediment Bucket -B
 Vandal Proof Screws -U

B SQ	05 (125)	06 (150)	07 (180)	08 (205)	09 (230)	10 (255)
H	2 (51)	2 (51)	2 1/4 (57)	2 1/2 (64)	2 1/4 (57)	2 1/4 (57)
X MIN	1 1/4 (32)	1 1/4 (32)	1 1/4 (32)	1 1/2 (38)	1 1/2 (38)	1 1/2 (38)
X MAX	2 1/4 (57)	2 1/4 (57)	2 1/4 (57)	2 1/2 (64)	2 1/4 (57)	2 3/8 (60)

LIGHT DUTY

SUFFIX -B

Specify Type, Size & Finish eg: B05NB
 *Not available for 05" (125) size

REINFORCED ROUND STRAINER

FUNCTION: Used in finished floors where light wheeled loads are anticipated.

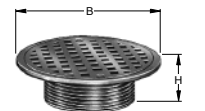

MATERIALS:
 Chrome Plated -CP
 Polished Bronze -PB
 Nickel Bronze -NB

VARIATIONS:
 Flapper Type Backwater Valve (Specify Suffix -CV)
 Sediment Bucket -B
 Vandal Proof Screws -U

B DIA	05 (125)	06 (150)	08 (205)	10 (255)
H	2 (51)	2 (51)	2 1/2 (64)	2 3/4 (70)
MIN	1 1/4 (32)	1 1/4 (32)	1 1/2 (38)	1 7/8 (48)
MAX	2 1/4 (57)	2 1/4 (57)	2 1/2 (64)	2 3/4 (70)

LIGHT DUTY

SUFFIX -C

Specify Type, Size & Finish eg: C06NB

TILE FLANGE

FUNCTION: Provides integral flange set 5/32"(4) below rim to receive floor covering. Flange may have option of tapped holes for securing pan and gasket.

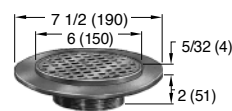

MATERIALS:
 Chrome Plated -CP
 Polished Bronze -PB
 Nickel Bronze -NB

VARIATIONS:
 Flapper Type Backwater Valve (Specify Suffix -FV)
 Holes in Flange -SH
 Sediment Bucket -B
 Vandal Proof Screws -U

	X
MIN	MAX
1 1/4 (32)	2 1/8 (54)

LIGHT DUTY

SUFFIX -F

Specify Type, Size & Finish eg: F06NB

FLAPPER TYPE BACKWATER VALVE

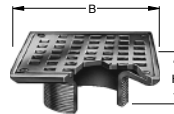

FUNCTION: Provides backwater protection at point where protection is needed.

MATERIALS:
 Chrome Plated -CP
 Polished Bronze -PB
 Nickel Bronze -NB

VARIATIONS:
 •Hinged Grate (Specify Suffix -AH)
 Vandal Proof Screws -U

B SQ	05 (125)	06 (150)	07 (180)	08 (205)
H	2 (51)	2 (51)	2 1/4 (57)	2 1/2 (64)
X MIN	1 1/4 (32)	1 1/4 (32)	1 1/4 (32)	1 1/2 (38)
X MAX	2 1/4 (57)	2 1/4 (57)	2 1/4 (57)	2 1/2 (64)

LIGHT DUTY

SUFFIX -AV

Specify Type, Size & Finish eg: AV05NB
 *Not available for 05" (125) size

STRAINER HEAD w/SQUARE HINGED COVER

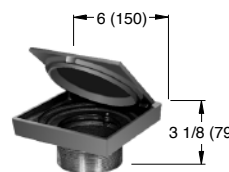

MATERIALS:
 Chrome Plated -CP
 Polished Bronze -PB
 Nickel Bronze -NB

VARIATIONS:
 Gasketed Water Tight Cover -GC
 Secured Cover -SC
 Secondary Strainer Grate-SG

LIGHT DUTY

SUFFIX -BS

Specify Type, Size & Finish eg: BSNB

REINFORCED TRACTOR STRAINER

FUNCTION: Used in finished floors where light weight wheeled loads are anticipated and loose set non-tilt tractor grate is desired.

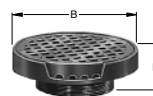

MATERIALS:
 Cast Iron -CI
 Chrome Plated -CP
 Polished Bronze -PB
 Nickel Bronze -NB

VARIATIONS:
 Flapper Type Backwater Valve (Specify Suffix -DV or -EV)
 Sediment Bucket -B
 Vandal Proof Screws -U

SUFFIX	B DIA	H	X	
-D	07 (180)	3 1/4 (83)	2 5/8 (67)	3 1/2 (89)
-E	09 (230)	3 1/2 (89)	2 3/4 (70)	3 1/2 (89)

LIGHT DUTY

SUFFIX -D-E

Specify Type, Size & Finish eg: D07PB
 E09PB

ADJUSTABLE STRAINER HEAD

FUNCTION: Used in a non-traffic area when a funnel type strainer head is required and space does not allow use of the 3500 series funnel. The extended rim allows use as an anti-flood and anti-splash drip pan.

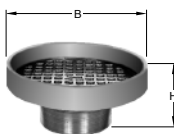

VARIATIONS:
 Flapper Type Backwater Valve (Specify Suffix -F37V or F38V)

MATERIALS:
 Cast Iron -CI
 Chrome Plated -CP
 Galvanized Cast Iron -G
 Polished Bronze -PB
 Nickel Bronze -NB

SUFFIX	-F37	-F38
B DIA	07 (180)	09 (230)
H	3 1/4 (83)	3 1/2 (89)
X MIN	2 5/8 (67)	2 3/4 (70)
X MAX	3 1/2 (89)	3 1/2 (89)

NON-TRAFFIC

SUFFIX -F37-F38

Specify Type, Size & Finish eg: F37NB F38CP

L	10-26-20
K	7-29-19
J	6-18-19
H	11-3-16

Rev. Finish (Tractor Strainer)
 Added Load Rating(s)
 Revised DIA to SQ Suf -AV, -B
 Revised Suffix-A

MW
 MW
 TBW
 TBW

CL
 JM
 TK
 CL

FIGURE NUMBER

2010 SERIES OPTIONAL STRAINER HEADS





MEMBER OF:

LOCATION

OPTIONAL STRAINER HEADS

DRAWING NUMBER: PM0457 SH 2 of 2
 SIZE: A
 SCALE: NONE
 DATE: 5-17-85
 APPROVED BY: TD
 CHECKED BY: TD
 DRAWN BY: PJ
 2010 SERIES OPTIONAL STRAINER HEADS

ASSUME NO RESPONSIBILITY OR USE OF SUPERSEDED OR VOID DATA
 DIMENSIONS ARE SUBJECT TO MANUFACTURERS TOLERANCE AND CHANGE WITHOUT NOTICE

LOW DOME STRAINER

FUNCTION: Used in gutters and recessed areas where excessive debris build-up is expected. Dome insures drainage even when partly covered.

MATERIALS:
 Chrome Plated -CP
 Polished Bronze -PB
 Nickel Bronze -NB

VARIATIONS:
 Flapper Type Backwater Valve (Specify Suffix -GV)
 Sediment Bucket -B
 Vandal Proof Screws -U

B DIA	05 (125)	06 (150)	08 (205)
H	2 (51)	2 (51)	2 1/2 (64)
MIN	1 1/4 (32)	1 1/4 (32)	1 1/2 (38)
MAX	2 1/4 (57)	2 1/4 (57)	2 1/2 (64)

SUFFIX -G Specify Type, Size & Finish eg: G08PB

SOLID HINGED COVER

FUNCTION: Used in areas where intermittent drain use is required. Solid cover prevents intrusion of chips, saw-dust, etc., which are swept up before cover is opened for washdown. The secondary strainer prevents debris from entering the waste line.

MATERIALS:
 Chrome Plated -CP
 Polished Bronze -PB
 Nickel Bronze -NB

VARIATIONS:
 Flapper Type Backwater Valve (Specify Suffix -GV)
 Vandal Proof Screws -U

B DIA	05 (125)	06 (150)	07 (180)	08 (205)
H	2 (51)	2 (51)	2 1/4 (57)	2 1/2 (64)
X MIN	1 1/4 (32)	1 1/4 (32)	1 1/4 (32)	1 1/2 (38)
X MAX	2 1/4 (57)	2 1/4 (57)	2 1/4 (57)	2 1/2 (64)

SUFFIX -H Specify Type, Size & Finish eg: H05CP

SPANNER WRENCH COVER

FUNCTION: Solid gas tight, vandal proof, threaded cover for areas where intermittent drain use is required.

MATERIALS:
 Chrome Plated -CP
 Polished Bronze -PB
 Nickel Bronze -NB

VARIATIONS:
 Flapper Type Backwater Valve (Specify Suffix -JV)
 Sediment Bucket -B

MEDIUM DUTY

X	MIN	MAX
	2 (51)	3 (76)

SUFFIX -J Specify Type, Size & Finish eg: J06NB

REINFORCED SQUARE STRAINER

FUNCTION: Used in finished floors where some light wheeled traffic is anticipated.

MATERIALS:
 Chrome Plated -CP
 Polished Bronze -PB
 Nickel Bronze -NB

VARIATIONS:
 Flapper Type Backwater Valve (Specify Suffix -KV)
 Sediment Bucket -B
 Vandal Proof Screws -U

B SQ	05 (125)	06 (150)	07 (180)	08 (205)
H	2 (51)	2 (51)	2 1/4 (57)	2 1/2 (64)
X MIN	1 1/4 (32)	1 1/4 (32)	1 1/4 (32)	1 1/2 (38)
X MAX	2 1/4 (57)	2 1/4 (57)	2 1/4 (57)	2 1/2 (64)

SUFFIX -K Specify Type, Size & Finish eg: K07CP

RECTANGULAR STRAINER

FUNCTION: Used in finished floors where light wheeled loads and or heavy foot traffic are anticipated.

MATERIALS:
 Chrome Plated -CP
 Polished Bronze -PB
 Nickel Bronze -NB

VARIATIONS:
 Sediment Bucket -B
 Vandal Proof Screws -U

LIGHT DUTY

SUFFIX	L	M	N	P	R	T
B x B'	4 1/2(115)x8(205)	4(100)x12(305)	5(125)x9(230)	5(125)x13(330)	6(150)x10(255)	5(125)x17(430)
H	2 1/4 (57)	2 1/2 (64)	2 1/4 (57)	3 (76)	2 1/4 (57)	3 (76)
X MIN	1 3/8 (35)	1 7/8 (48)	1 3/8 (35)	2 1/8 (54)	1 3/8 (35)	2 1/4 (57)
X MAX	2 3/8 (60)	2 3/4 (70)	2 3/8 (60)	3 (76)	2 3/8 (60)	3 1/8 (79)

SUFFIX -L-M-N-P-R-T Specify Type, Size & Finish eg: LNB

ANGLE STRAINER

FUNCTION: Shower room drain set at wall and floor junction. Vertical grate openings prevent drain stoppage should flat surface become covered.

MATERIALS:
 Chrome Plated -CP
 Polished Bronze -PB
 Nickel Bronze -NB

VARIATIONS:
 Vandal Proof Screws -U

LIGHT DUTY

SUFFIX	B	C	D	X	
	MIN	MAX	MIN	MAX	
-V	3 1/2 (89)	3 1/2 (89)	4 1/2 (115)	1 5/8 (41)	2 5/8 (67)
-W	6 3/4 (170)	6 3/4 (170)	6 1/2 (165)	1 5/8 (41)	2 5/8 (67)

SUFFIX -V -W Specify Type, Size & Finish eg: VPB, WNB

EXTENSION ADAPTOR

FUNCTION: Used when a strainer head must be raised to accommodate deeper floor fill.

REGULARLY FURNISHED:
 Duco Cast Iron -CI

MATERIALS:
 Cast Bronze -CB
 Galvanized Cast Iron -G

NOTE: Extension can be stacked for increased maximum adjustment.

SUFFIX -X

OVERFLOW WITH STANDPIPE

FUNCTION: Used as overflow drain in decorative pools, fish ponds or similar areas. Dome prevents floating objects from entering drain line.

MATERIALS:
 Chrome Plated -CP
 Nickel Bronze -NB
 Polished Bronze -PB

VARIATIONS:
 Less Dome -LD
 Standpipe Height other than 6" (150) (Specify Height)

SUFFIX	A	X	
	SIZE	MIN	MAX
-Y	2 (51)	3/4 (19)	2 1/8 (54)
-Z	3 (76)	3/4 (19)	2 1/8 (54)

SUFFIX -Y-Z Specify Type, Size & Finish eg: YCP, ZCP

HEAVY DUTY ADJUSTABLE

FUNCTION: Used in finished floors where light wheeled loads and or heavy foot traffic are anticipated.

MATERIALS:
 Polished Bronze -PB
 Rough Bronze -RB
 Nickel Bronze -NB

VARIATIONS:
 Flapper Type Backwater Valve (Specify Suffix -69V)
 Sediment Bucket -B
 Vandal Proof Screws -U

MEDIUM DUTY

SUFFIX -69 eg: A06NB-69

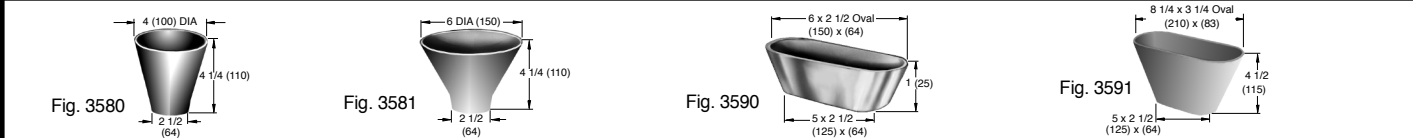

L	7-29-19	Added Load Rating(s)	MW	JM	FIGURE NUMBER 2010 SERIES OPTIONAL STRAINER HEADS 2 of 2
K	10-20-17	Rev. Materials Suffix -H, -V-W	TBW	CL	
J	1-17-12	Rev. Variations of Suffix -J	TBW	AM	
H	8-24-99	Revised Tables	TBW	BS	
G	6-11-99	Revised Tables	CMD		
REV.	DATE	DESCRIPTION	BY	CKD. BY	

NOTE: Dimensions shown in parentheses are in millimeters.



WARNING: Cancer and Reproductive Harm - www.P65Warnings.ca.gov