

D
DRAWING NUMBER S1510-CAN
SIZE A
SCALE: NONE
DATE: 1-14-85
APPROVED BY: SB
CHECKED BY: SB
DRAWN BY: PL
1510, 1520, 1530, 1540-CAN
FIGURE NUMBER



JAY R. SMITH CO.
PLUMBING & DRAINAGE PRODUCTS
959 Alness Street, North York, Ontario M3J 2J1
TEL: (416) 736-9610 FAX: (416) 736-3789

LOCATION

SCUPPER DRAINS

FUNCTION: Used at junction of roof and parapet. Side outlet (90°) drains may be connected to outside downspout by using drain in conjunction with Fig. 1550 downspout adaptor. When connecting to an inside leader, the 45° outlet drains may be easily offset into the wall. The flush grate prevents obstruction to traffic. The angle grate prevents debris from blocking drainage.

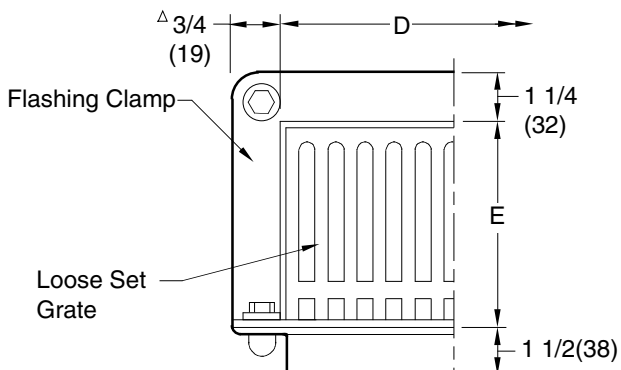
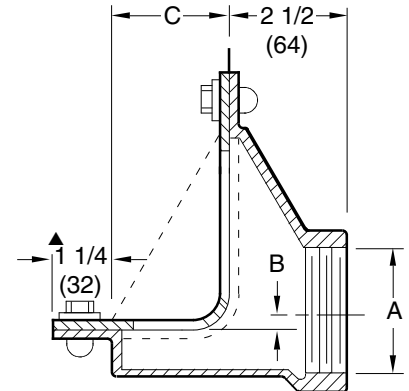



Fig. 1520 Shown



90° THREADED OUTLET
 Fig. 1510T ANGLE GRATE
 Fig. 1520T FLUSH GRATE

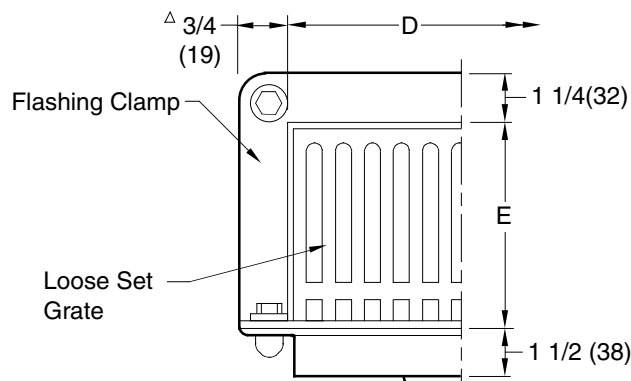
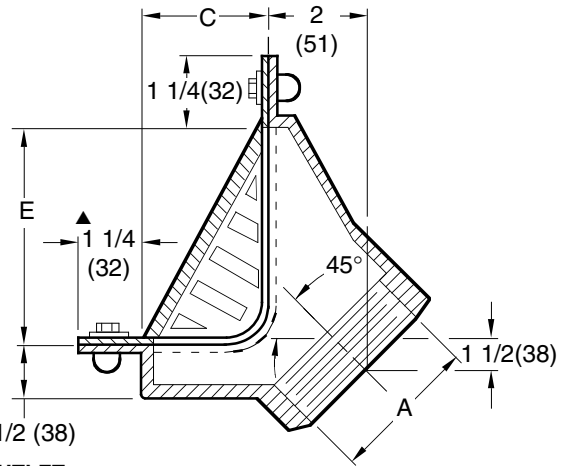



Fig. 1530 Shown



45° THREADED OUTLET
 Fig. 1530T ANGLE GRATE
 Fig. 1540T FLUSH GRATE



A SIZE	B	C	D	E	FREE AREA	
					ANGLE	FLUSH
02(50)	*				17.75	20
03(75)	1/4(6)				SQ IN	SQ IN
04(100)	1(25)	3 1/4 (83)	8 3/4 (220)	5 (125)	(115)SQ CM	(129) SQ CM
05(125)	1 3/4(44)	4 1/4	10 1/2	6 1/2	35SQ IN	40 SQ IN
06(150)	1 3/4(44)	(110)	(265)	(165)	(226)SQ CM	(258) SQ CM

* 02"(50) Size 1510/1520 "B" Dimension is 1/4"(6) Below Flange, Not Above as Shown.
 Δ For 05(125) & 06"(150) size add 1/2(13)".
 ▲ For 05(125) & 06"(150) size reduce by 3/16(5)".





REGULARLY FURNISHED:

Duco Cast Iron Body, Flashing Clamp and Loose Set Grate. Type of Outlet and Grate as indicated by Figure Number Selected.

VARIATIONS:

-  Downspout Adaptor (Specify Fig. 1550)
-  Secured Grate -SG
-  Secured Grate with Vandal Proof Screws -U

OPTIONAL MATERIALS:

-  Galvanized Cast Iron -G
-  Nickel Bronze Face -NB
-  Polished Bronze Face -PB
-  Rough Bronze Face -RB
-  Stainless Steel (Specify Fig. 9785)

NOTE: Dimensions shown in parentheses are in millimeters.

D	6-16-99	Revised Millimeters	CMD	BS	WEIGHT POUNDS	VOLUME CUBIC FEET	FIGURE NUMBER
C	7-1-96	Added Millimeters	CMD	BS			
B	6-4-93	Submittal Update	EMB	CR	1510, 1520, 1530, 1540-CAN		
A	6-18-86	Added Variation	PL	CR			
REV.	DATE	DESCRIPTION	BY	CKD.BY			

DIMENSIONS ARE SUBJECT TO MANUFACTURERS TOLERANCE AND CHANGE WITHOUT NOTICE
WE CAN ASSUME NO RESPONSIBILITY FOR USE OF SUPERSEDED OR VOID DATA