

M



**JAY R. SMITH CO.**  
PLUMBING & DRAINAGE PRODUCTS

959 Alness Street, North York, Ontario M3J 2J1  
TEL: (416) 736-9610 FAX: (416) 736-3789

LOCATION

DRAWING NUMBER  
S1419-CANSIZE  
ASCALE:  
NONEDATE:  
5-24-85APPROVED BY:  
BSCHECKED BY:  
TDDRAWN BY:  
CR

1419-CAN

WE CAN ASSUME NO RESPONSIBILITY FOR USE OF SUPERSEDED OR VOID DATA  
DIMENSIONS ARE SUBJECT TO MANUFACTURERS TOLERANCE AND CHANGE WITHOUT NOTICE

# PROMENADE DECK DRAIN

## FOR SPECIAL ROOF APPLICATIONS

**FUNCTION:** Used in roof deck systems where the insulated membrane assembly method of waterproofing is provided. Used where a liquid membrane waterproofing is installed on a flat roof construction which is designed for parking decks or promenades for recreational purposes.

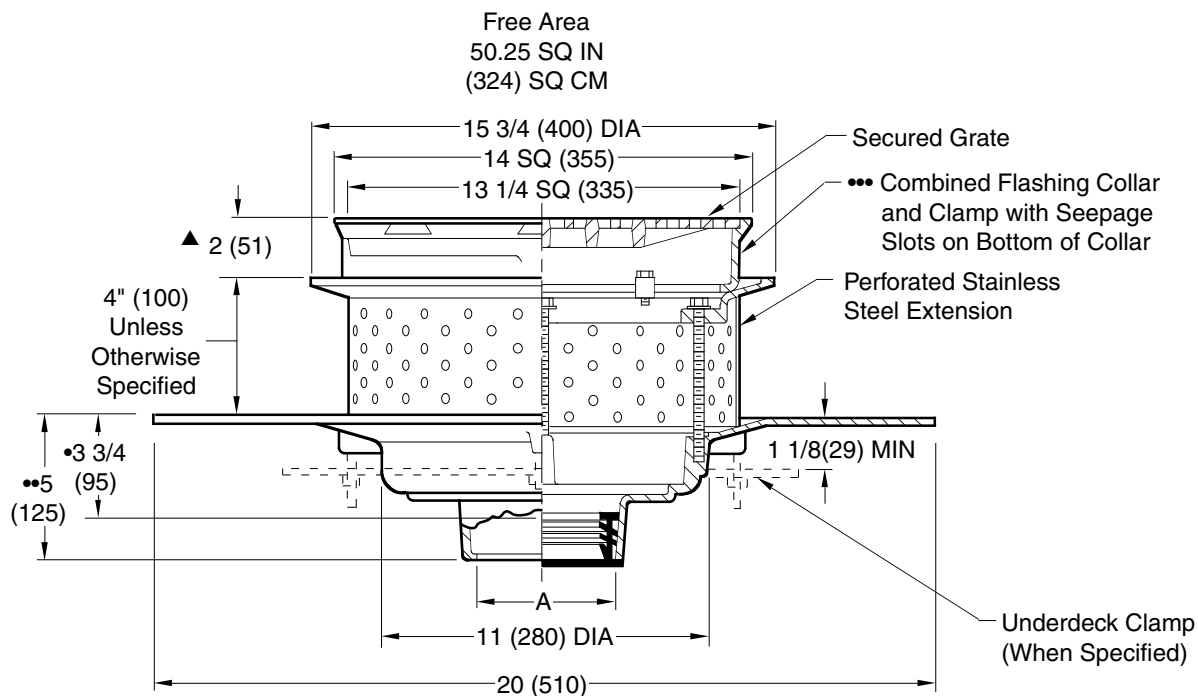



•This Dimension to Internal Stop of Speedi-Set Gasket.

••Same for Caulk, NO-HUB and Speedi-Set. 3 3/4(95) for Threaded.

•••Specify Suffix-W for Applications Requiring "Loose-Set" Pavers.

▲Add 1/8 "(3) when bronze top is specified.

A (Pipe Size) = 02(50), 03(75), 04(100), 05(125) and 06(150)







 Fig. 1419C . . . . CAULK OUTLET  
 Fig. 1419Y . . . . NO-HUB OUTLET

**NOTE:** Recommended deck opening 14" (355)





### REGULARLY FURNISHED:

Duco Cast Iron Body, Perforated Stainless Steel Extension, Cast Iron Top Frame and Heavy Duty Secured Grate.

### VARIATIONS:

 Expansion Joint (Specify Fig. 1710)  
 Extension (Specify Height) -E  
 "L" Shaped Underdeck Clamp -CL  
 L Speedi-Set Service Weight  
02(50), 03(75) & 04"(100) sizes only  
 LXH Speedi-Set Extra Heavy  
02(50), 03(75) & 04"(100) sizes only  
 Underdeck Clamp -C  
 T Threaded Outlet

### OPTIONAL MATERIALS:

 Ductile Iron Grate -M  
 Galvanized Cast Iron -G  
 Nickel Bronze Top -NB  
 Polished Bronze Top -PB

**NOTE:** Dimensions shown in parentheses are in millimeters.

**NOTE:** Floor drains or area drains used to drain areas subject to rainfall should have an open area equal to twice the cross sectional area of the connecting pipe.

M  
L  
K12/11/03  
2/2/01  
12/13/99Removed C2 Variation  
Rev. Opt. Mat.  
Submittal UpdateJJ  
RN  
JJBW  
CL  
BSWEIGHT  
POUNDSVOLUME  
CUBIC FEET

FIGURE NUMBER

1419-CAN

REV.

DATE

DESCRIPTION

BY

CKD. BY